

MINI-IMPLANT

MINI IMPIANTI MONOFASICI

company profile

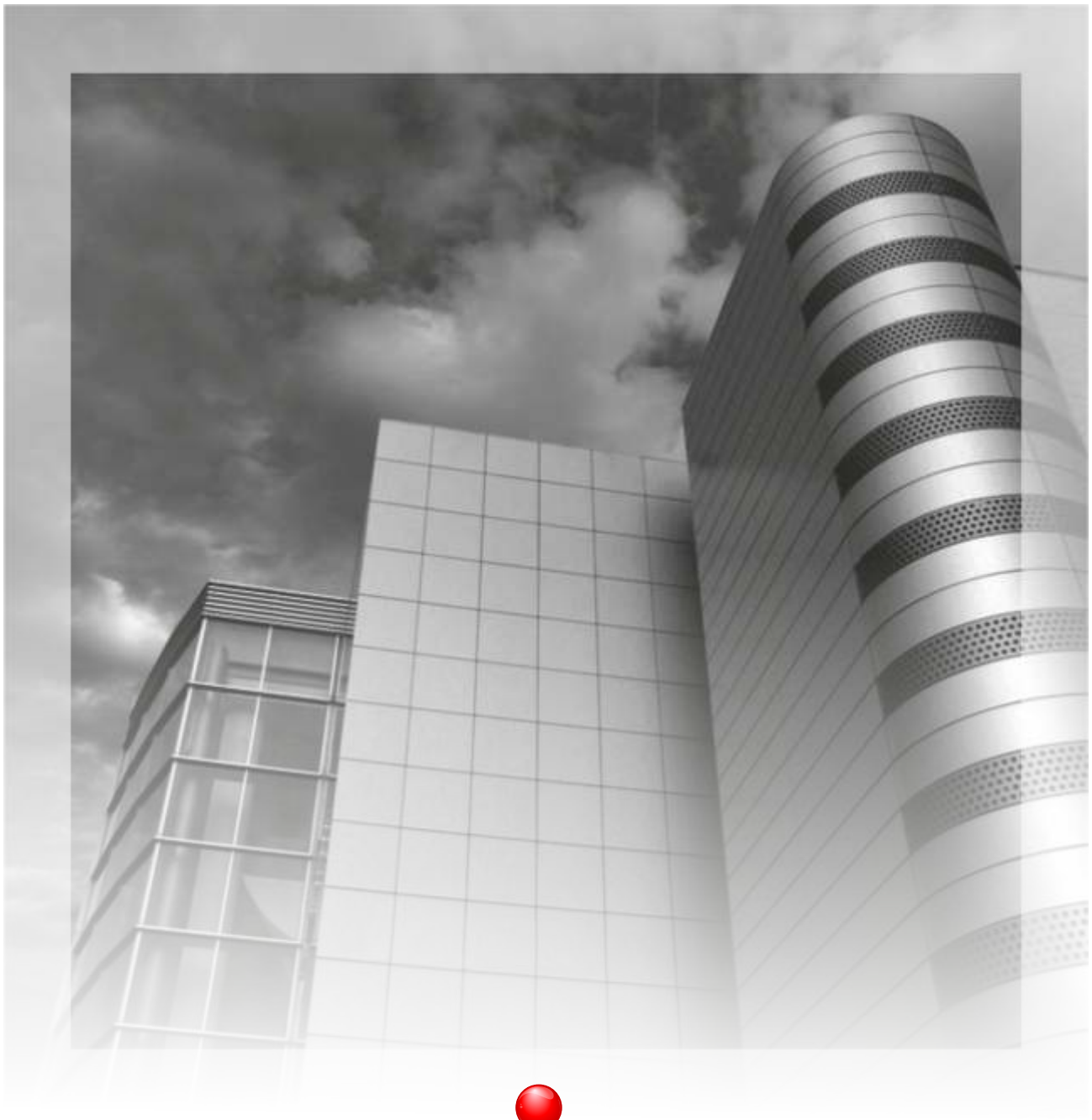

RESISTA[®]

Marchio di proprietà della **Ing. Carlo Alberto ISSOGLIO & C. S.r.l.** identifica l'intera gamma di prodotti concepiti dall'azienda per soddisfare le esigenze di odontoiatri ed odontotecnici.

since 1946

RESISTA è sinonimo di garanzia, equilibrio e continuità, noto in tutto il mondo.



RESISTA, trademark owned by Ing. Carlo Alberto Issoglio & C. S.r.l. , identifies the full range of products designed by the company to meet the needs of dentists and dental technicians.

RESISTA is known all over the world since 1946, and synonymous of guarantee, balance and continuity.

company profile

L'azienda dispone di un complesso produttivo per la realizzazione di dispositivi medici, tra i più moderni del settore, situato ad Omegna, una bellissima cittadina che si affaccia sul Lago d'Orta.

Con impegno, vanto ed orgoglio, il personale tecnico e scientifico del reparto Ricerca & Sviluppo è quotidianamente dedicato a promuovere l'innovazione ed il miglioramento dei nostri prodotti e processi.



Negli anni, il marchio **RESISTA** è diventato anche sinonimo di risposta rapida e qualitativa ai cambiamenti del mercato e alle esigenze dell'odontoiatria moderna.

Qualità, Prezzo e Servizio riassumono in tre semplici parole la percezione quotidiana degli utilizzatori dei prodotti marchiati **RESISTA**.



The company has one of the most ip-to-date manufacturing site for the medical devices, located in Omegna, a beautiful town on Orta Lake, Italy.

With commitment, merit and pride, the technical and scientific staff of the R&D department is daily involved to promote innovation and the improvement of our products and processes.

Over the years, the **RESISTA** brand has also become synonymous of fast and qualitative response to market changes and the needs of modern dentistry.

Quality, Price and Service summarize in three simple words the daily perception of the users of **RESISTA** branded products.

the choice

RICERCA & SVILUPPO - Il programma R&D di Resista Group nasce dalle indicazioni provenienti dal mondo clinico unite alla nostra esperienza maturata nel campo dei dispositivi medici impiantabili.

Con l'utilizzo di programmi di modellazione 3D e sofisticati sistemi computerizzati simuliamo le geometrie finali ed il design, sviluppando le fasi di prototipizzazione rapida dei progetti.



INNOVAZIONI - Resista Group è strutturata per soddisfare tutte le esigenze del metal-implant con una avanzata tecnologia di concezione, prototipizzazione ed ingegnerizzazione finale del prodotto per arrivare a soluzioni innovative.

La validazione viene eseguita in collaborazione con Istituti di Ricerca accreditati in conformità ai requisiti degli Standard Internazionali.



RESEARCH & DEVELOPMENT - The R&D Resista Group's program stems from indications from the clinical world combined with our experience in the field of implantable medical devices.

Due to the use of 3D modeling programs and sophisticated computer systems, we simulate the final geometries and the design, developing the rapid prototyping phases of the projects.

INNOVATIONS - Resista Group is structured to meet all the needs of the metal-implant with an advanced conception technology, prototyping and final product engineering to arrive at innovative solutions. Validation is carried out in collaboration with accredited Research Institutes following the International Standards Requirements.

the choice

QUALITÀ DI PROGETTO E PROCESSO - ICIM Spa ha certificato la **Ing. C. A. Issoglio & C. S.r.l.** in accordo alle normative **UNI EN ISO 9001** e **UNI EN ISO 13485** nel rispetto di tutte le normative vigenti relative ai prodotti e servizi offerti.

Ogni dipendente che ricopre differenti ruoli (tecnici, ingegneristici, amministrativi, commerciali, operatori meccanici, ecc), segue linee guida ed obiettivi per un unico fine: il miglioramento continuo.



OBIETTIVO PRINCIPALE - La soddisfazione del cliente è il nostro obiettivo. Il fattore vincente è la capacità dell'azienda a risolvere nel breve qualsiasi tipo di richiesta.

Il supporto tecnico fornito dagli specialisti di prodotto, la disponibilità, l'efficienza e la cordialità sono il punto di forza della nostra struttura.



PROJECT AND PROCESS QUALITY - ICIM Spa certified **Ing. C. A. Issoglio & C. S.r.l.** in accordance with **UNI EN ISO 9001** and **UNI EN ISO 13485** in compliance with all current regulations relating to the products and services offered. Every employee covering different roles (technical, engineering, administrative, commercial, mechanic operators, etc.), follows guidelines and objectives for a single purpose: continuous product improvement.

MAIN OBJECTIVE - Customer satisfaction is our objective. The winning factor is the company's ability to quickly resolve any type of request. The technical support provided by Product Specialists, availability, efficiency and friendliness are the strengths of our structure.

the project

CONCETTI BIOMECCANICI - Il successo della metodica implantare **Resista Group** è frutto di approfonditi studi sul design dei prodotti e sulla tecnologia di produzione. I risultati clinici a lungo termine sono, infatti, fortemente influenzati dalla precisione e dalla qualità.

Il **processo produttivo** viene eseguito da operatori altamente qualificati che, con l'ausilio dei sistemi elettronici CNC automatizzati, riescono ad ottenere risultati ottimali e riproducibili.



Le tolleranze di lavorazione, soprattutto negli **accoppiamenti protesici**, sono il nostro **gold standard** e vengono confinate tra i **7 - 10 μm** .

MATERIALI - Gli impianti sono realizzati in **Titanio ASTM Gr 4** (Norm. ISO 5832/2), le viti di ritenzione e le componenti protesiche sono realizzate in **Lega di Titanio ASTM Gr 5** (Norm. ISO 5832/3).



BIOMECHANICAL CONCEPTS - The **Resista Group** method success is the result of several product design studies and the high technology applied in the production. The precision and reliability of the implant has a strong influence on the long term clinical success.

The manufacturing process is carried out by high qualified operators, skilled enough to obtain optimal and reproducible results with the use of electronically controlled CNC machinery. The machinery tolerances, especially in **prosthetic connections**, are our **gold standard** and are between **7 - 10 μm** .

MATERIALS - The implants are made of Titanium ASTM Gr. 4 (ISO Standard 5832/2) and the screws and prosthetic components are made of Titanium ASTM Gr. 5 (ISO Standard 5832/3).

the project

TRATTAMENTI DI SUPERFICIE - Il processo di micro-sottrazione non contaminata, doppia acidificazione **DAE** (Double Acid Etching), modifica la micro rugosità degli impianti (**Ra, Rq**) texturizzando la superficie e massimizzando la bagnabilità ed il biomimetismo.

Il trattamento di superficie ed il processo di decontaminazione, brevettati da **Nobil Bio Ricerche**, sono in grado di migliorare le proprietà bio-chimiche degli impianti dentali **Resista**.

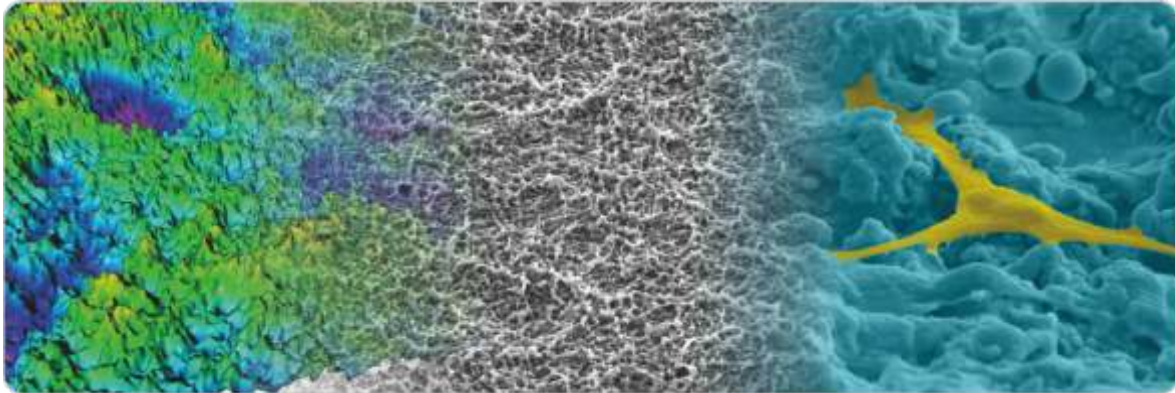

SISTEMA QUALITÀ - L'azienda è certificata in accordo alle norme **UNI EN ISO 9001** e **UNI EN ISO 13485** e ha ottenuto la marcatura **CE** sui propri dispositivi medici in accordo alla Direttiva Europea 93/42/CEE e ss.mm.ii. nel rispetto delle armonizzate di riferimento.

L'impegno è costante nel mantenimento della conformità.



SURFACE TREATMENTS - The non-contaminant micro-subtraction process, **DAE** (Double Acid Etching), changes the implant micro roughness (**Ra, Rq**) and the surface texture maximizing the wettability and biomimetic properties. The new surface treatment and decontamination process are patented by **Nobil Bio Ricerche** improving the bio-chemical properties of the implants.

QUALITY SYSTEM (QS) - **UNI EN ISO 9001** and **UNI EN ISO 13485** in compliance of Medical Devices Directives. We are qualified in the design and in the production management of dental implants, dental prosthesis, intraligamental anesthesia syringes and abrasive discs.

micro geometry

Il trattamento di superficie Micro-Nano Ruvido DAE accelera i processi di guarigione ossea

1. Rimuove i residui organici di lavorazione in combinazione con la Decontaminazione al Plasma d'Argon
2. Arrotonda gli angoli vivi eliminando i micro-difetti
3. Incrementa la superficie e la bagnabilità (idrofilia superficiale), migliorando l'adesione dei primi ponti di fibrina
4. Aumenta l'adesione proteica
5. Massimizza l'adesione cellulare con rugosità Micro-Nano Metriche ideali per l'ancoraggio dei filamenti di actina (filopodi)
6. Cambia la chimica superficiale del Titanio che migliorando in biocompatibilità incrementa la proliferazione e la vitalità cellulare

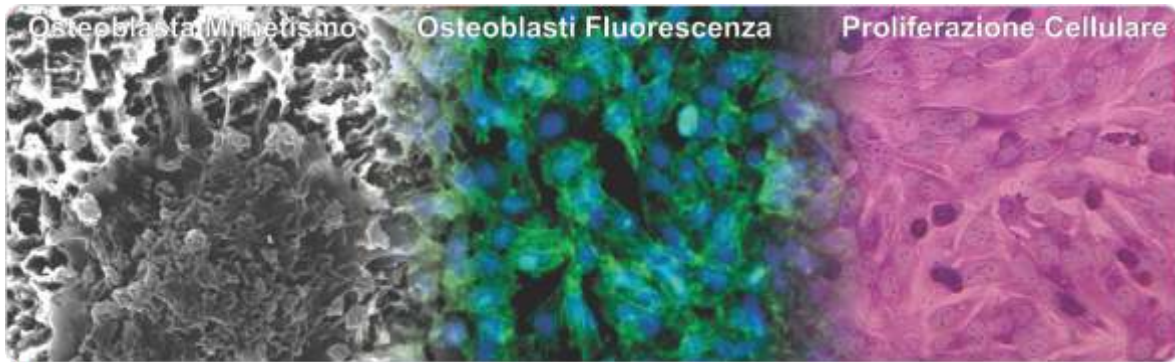

La topografia e la chimica di superficie interagiscono con i processi di differenziazione cellulare

La superficie implantare usa la microtopografia come linguaggio di comunicazione con le cellule del tessuto ospite. La pulizia in reattore al plasma freddo di Argon con confezionamento in ambiente controllato nell'assoluto rispetto delle procedure, gioca un ruolo fondamentale nel controllo delle endotossine adese (principale agente di risposta immunologica alle superfici implantari).

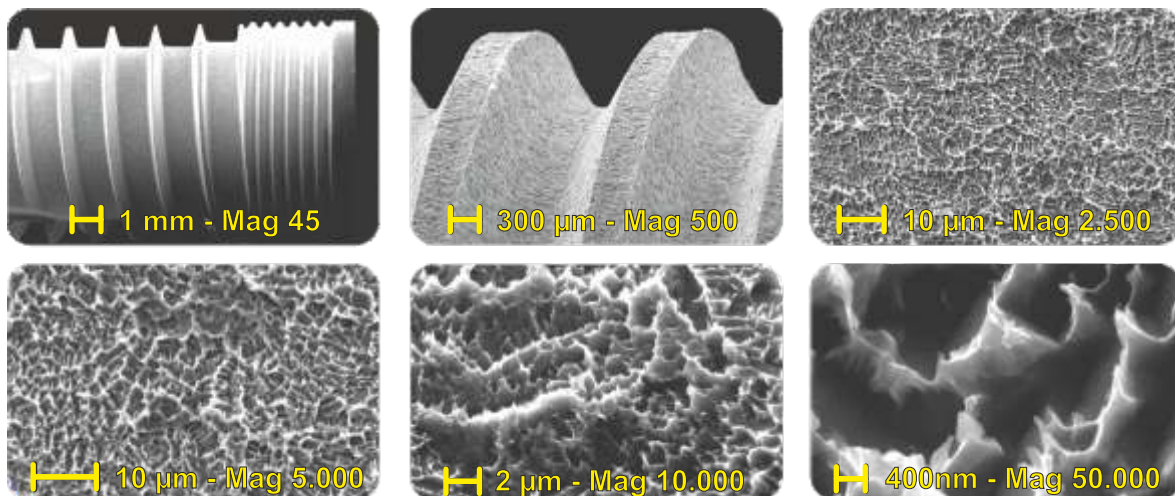

The Micro-Nano Rough DAE surface treatment speed up bone healing processes

1. Removes the manufacturing organic residuals along with Argon Plasma Cleaning
2. Smooths the edge and eliminates the micro-defects
3. Increases surface and wettability (hydrophilicity surface), improving the first fibrin bridges adhesion
4. Increases protein adhesion
5. Maximizes cellular adhesion through the Micro-Nano roughness suitable for actin filaments (phyllopods) anchoring
6. Changes the Titanium surface chemical characteristics improving the biocompatibility and increasing the cellular proliferation and vitality

Surface topography and chemistry interact with the cellular differentiation processes

The implant surface uses the microtopography as a communication language with the host tissue cells. The Plasma Argon Cold Cleaning with a controlled-environment packaging at a strict protocol procedures, play a key-role in the control of adhered endotoxins (main immunological response player to implant surfaces).

micro geometry - 4 treatments

DISTRIBUZIONE DEL TRATTAMENTO DI SUPERFICIE SULLA FORMA IMPLANTARE

Tutti gli impianti **Resista** presentano un trattamento di superficie localmente differenziato. La logica di distribuzione superficiale del trattamento è dettata dalla posizione endo-ossea dell'impianto che richiede caratteristiche differenti in funzione della presenza, più o meno ravvicinata della componente mucogengivale.

- 1. Superficie Machined:** Spazzolata, rettificata e mascherata nel processo di irruvidimento
- 2. Superficie Nanoruvida:** Trattamento veloce, nanoruvido con Ra medio inferiore al micron
- 3. Superficie Microruvida 3/5 μ :** Trattamento DAE, microruvido con Ra medio tra 3/5 micron
- 4. Superficie Microruvida 4/7 μ :** Trattamento DAE lento, microruvido con Ra medio tra 4/7 micron

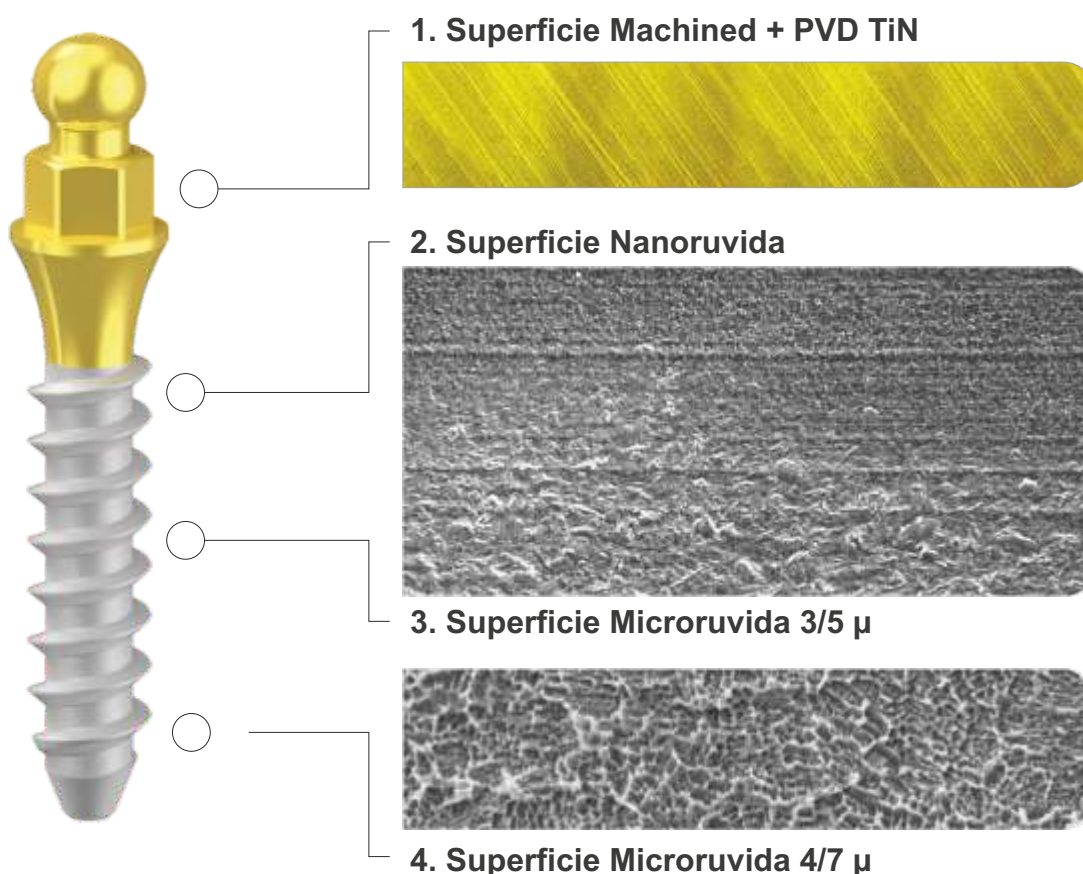

VEGF/VEGF-R/RUNX2 Upregulation in Human Periodontal Ligament Stem Cells Seeded on Dual Acid Etched Titanium Disk

Francesca Diomedè, Guya Diletta Marconi, Marcos F. X. B. Cavalcanti, Jacopo Pizzicannella, Sante Donato Pierdomenico, Luigia Fonticoli, Adriano Piattelli and Oriana Trubiani

Materials 2020, 13, 706; doi:10.3390/ma13030706



SURFACE TREATMENT DISTRIBUTION ON IMPLANT'S BODY

All the **Resista**'s implants have a surface treatment that is locally differentiated. The logic of surface treatment distribution is dictated by the endo-osseous implant position which requires different characteristics depending on the muco-gingival component presence around.

- 1. Machined Surface:** Brushed, rectify and protected during the roughening process
- 2. Nano-rough Surface:** Speedy treatment, nano-rough with average Ra less than one micron
- 3. Micro-rough Surface: 3/5 μ :** DAE Treatment, micro-rough with average Ra between 3/5 μ
- 4. Micro-rough Surface: 4/7 μ :** DAE Slow Treatment, micro-rough with average Ra between 4/7 μ

PUNTI DI FORZA DELLA LINEA IMPLANTARE RESISTA

- 1. Macro Geometrie:** Vastissima gamma di forme implantari per le differenti necessità in campo chirurgico (Cilindrici, Tapered, Attivi, Short, Mini ed Extra-Larghi)
- 2. Micro Geometrie:** Trattamenti di superficie differenziati (Full, Half e Machined) di ultima generazione (DAE Micro e Nano rugosi), decontaminati in Reattore al Plasma Freddo di Argon.



The Bacterial Anti-Adhesive Activity of Double-Etched Titanium (DAE) as a Dental Implant Surface

Morena Petrini, Alessandra Giuliani, Emanuela Di Campi, Silvia Di Lodovico, Giovanna Iezzi, Adriano Piattelli and Simonetta D'Ercole¹
International Journal of Molecular Sciences 2020, 21, 8315; doi:10.3390/ijms21218315

- 3. Mounter Multifunzione:** 4 componenti in un unico articolo (Mounter, Transfer, Abutment e Mounter per Chirurgia Computer Guidata) per massimizzare la resa ed ottimizzare i costi.
- 4. Componenti protesiche:** Vastissima gamma di varianti protesiche con tolleranze di lavorazione sulle connessioni di 7 micron, con profili emergenti curvilinei, connessioni piane e coniche, platform switching, viti in Titanio Dorate e rivestimenti in PVD TiN (più estetica e minore ritenzione di placca).
- 5. Strumentario Chirurgico:** Frese chirurgiche **3-Tech**, massima efficienza, minima invasività, basso coefficiente di attrito, tecnologia **PRO MSD** per applicazione osseo-densificante in senso antiorario, lunga durata, perfetta visibilità delle tacche laser e stop chirurgici millimetrati.



THE RESISTA'S IMPLANT LINE STRONG POINTS

- 1. Macro Geometry:** A vast range of implant shapes for different surgical needs (Cylinder, Tapered, Active, Short, Mini and Extra-Large)
- 2. Micro Geometry:** Last Generation Differentiated Surface (Full, Half and Machined) treated (DAE Micro and Nano rough), decontaminated in Argon Cold Plasma Reactor.
- 3. Multifunctional Mounter:** 4 components in a single article (Mounter, Transfer, Abutment and Mounter for Computer Guided Surgery) to maximize result and minimize costs.
- 4. Prosthetic Parts:** A very wide range of prosthetic variants with 7/10 micron machining tolerances on the connection, with emerging curvilinear profiles, flat and conical connections, platform switching, golden titanium screws and PVD TiN coatings (more aesthetic and less retention of dental plaque).
- 5. Surgical Instruments:** Surgical Drills **3-Tech**, maximum efficiency, minimum trauma, smaller friction coefficient, **PRO MSD** technology for counterclockwise bone densifying application long, lasting resistance, perfect visibility of laser marking and surgical millimeters stop.

technology

COERENZA E LOGICA NEL RAPPORTO DIAMETRO FRESA/DIAMETRO NOCCIOLO-IMPIANTO

Le progettazioni della forma degli strumenti rotanti si basano sulla logica di coerenza tra la dimensione degli impianti, nell'ingombro esterno, nel nocciolo interno e per la loro capacità di penetrazione.

Gli **impianti cilindrici** della linea **IC** presentano una porzione apicale affusolata per una lunghezza di 3mm. Gli **impianti conici** della linea **IK** presentano una porzione apicale affusolata per una lunghezza di 5mm.

Le frese si presentano rispettivamente con 2 / 3 sezioni apicali, adeguate per una preparazione del tunnel implantare rispetto alla geometria dell'impianto, mantenendo il miglior BIC di interfaccia osso / impianto.

Ogni gradino è fornito di un tagliente affilato per agevolare la penetrazione, minimizzando l'attrito ed il surriscaldamento.

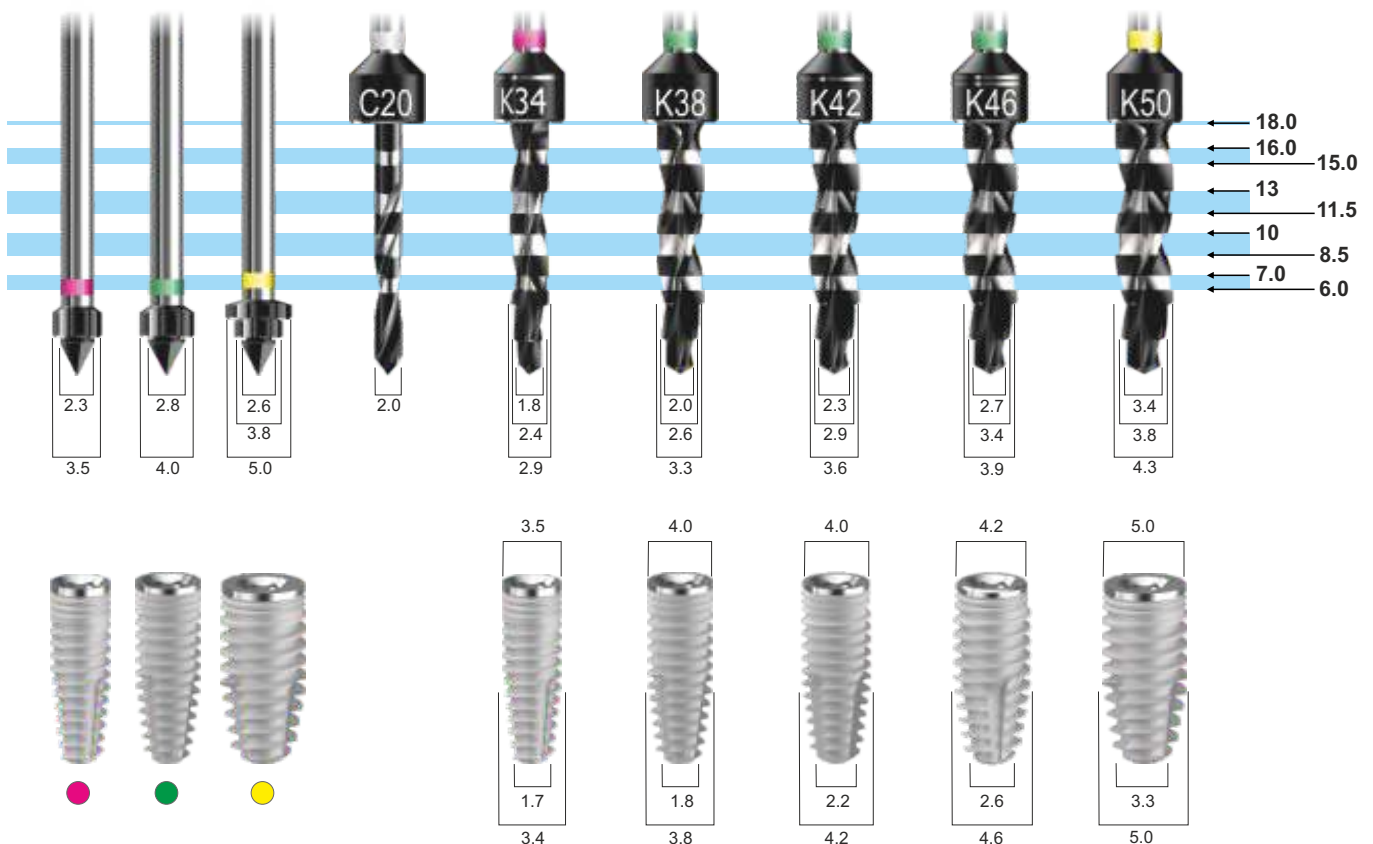

Various bio-mechanical factors affecting heat generation during osteotomy preparation: A systematic review

Chirag J Chauhan¹, Darshana N Shah¹, Foram B Sutaria¹

Indian J Dent Res. Jan-Feb 2018;29(1):81-92. doi: 10.4103/ijdr.IJDR_729_16.



LOGIC RELATION BETWEEN DRILL AND IMPLANT CORE

The rotary instruments design and shape is based on the logical coherence between the implants size, in the external dimensions, internal core and their penetration properties.

The **IC** line **Cylindrical Implants** have a tapered apical portion 3mm long.

The **IK** line **Conical Implants** have a tapered apical portion 5mm long.

The drills have respectively 2/3 apical sections, suitable for the implant tunnel preparation, with respect to the implant geometry, maintaining the best bone implant contact (BIC).

Each step drill is equipped with a sharp cutting edge to facilitate penetration, minimizing friction and overheating.

PRO MSD drilling technology

IL CONDIZIONAMENTO DEI PROTOCOLLI CHIRURGICI

Le geometrie implantari differenziate nella macro/micro forma, prevedono applicazioni diverse sia in funzione delle necessità chirurgico/protesiche (carico immediato, carico precoce o carico posticipato) sia in base alle condizioni della componente ossea/anatomica del paziente da riabilitare.

Tuttavia, si richiedono spesso indispensabili manovre chirurgiche e protocolli alternativi per migliorare le prestazioni implantari in funzione delle caratteristiche morfologiche delle strutture ossee residue.

La riuscita di tali manovre, come risultato di applicazioni combinate di strumenti e protocolli personalizzati, rappresenta la differente risposta al problema in relazione alle personali capacità operatorie ed alla presenza più o meno marcata di strumenti e mezzi adeguati all'applicazione delle stesse.

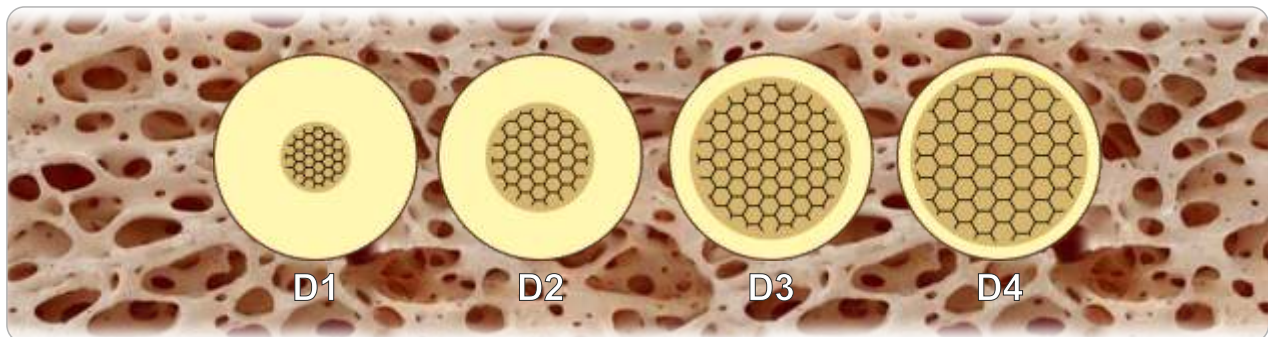

✓ Bone classification: clinical-histomorphometric comparison

Trisi P, Rao W. - Clin Oral Implants Res. 1999 Feb;10(1):1-7. doi: 10.1034/j.1600-0501.1999.100101.x.

OSSEODENSIFICAZIONE MECCANICA IN ROTAZIONE ANTIORARIA

L'osseodensificazione tramite strumenti rotanti è una recente tecnica chirurgica per la preparazione del sito implantare che può essere associata a differenti protocolli, applicabili in quelle particolari condizioni anatomiche dove la qualità ossea risulta scarsa e con dimensioni verticali / orizzontali insufficienti.

Questo approccio di osseo-condensazione osteotomica non sottrattiva, genera un aumento della densità ossea peri-osteotomica, con il risparmio del tessuto stesso e l'incremento della stabilità primaria implantare.



THE CONDITIONING OF SURGICAL PROTOCOLS

The differentiated implant geometries in the macro/micro shape provide for different applications, both according to the surgical/prosthetic requirements (immediate loading, early loading or postponed loading) and according to the conditions of the bone/anatomical component of the patient who needs rehabilitation. However, surgical maneuvers and alternative protocols are often required to improve implant performance, according to the morphological characteristics of the residual bone structures.

The success of these maneuvers, that is often the result of a customized tools and protocols combination, represents the different response to the problem in relation to the personal operating skills and the presence of tools suitable for their application.

MECHANICAL OSSEODENSIFICATION IN ANTI-CLOCKWISE ROTATION

The osseodensification using rotary instruments is a recent surgical technique for the implant site preparation that can be associated with different protocols; these protocols can be used in those particular anatomical conditions such as poor bone quality and insufficient vertical / horizontal dimensions.

This non-subtractive osteotomic bone-condensation approach produces an increase in peri-osteotomic bone density, saving the tissue and increasing the primary implant stability.

PRO MSD drilling technology

FRESE CHIRURGICHE RESISTA PRO MSD - Modular Surgical Drilling

Le Frese Chirurgiche Modulari a geometria variabile sono frese elicoidali a 3 sezioni con spoglia raggiata progressiva, utilizzabili in senso **orario** ed **antiorario**.

Il diametro di ogni fresa varia, con un rapporto costante, di 0,4mm (30/34/38/42/46/50), permettendo così all'operatore la scelta di utilizzo in funzione della qualità ossea (sovra-preparazione o sotto-preparazione).

Tutte le frese sono rivestite con un coating di lubrificante solido in diamante sintetico DLC (Diamond Like Carbon) che massimizza le prestazioni in termini di resistenza meccanica e riduzione dell'attrito.

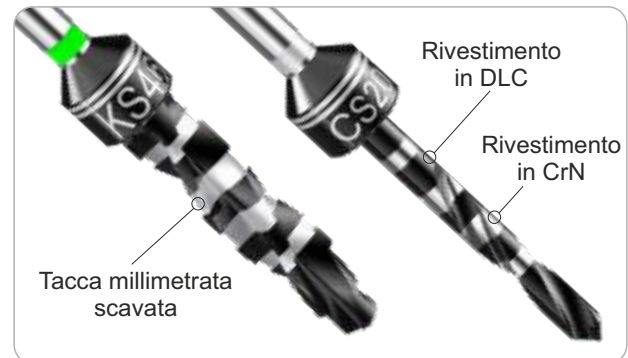
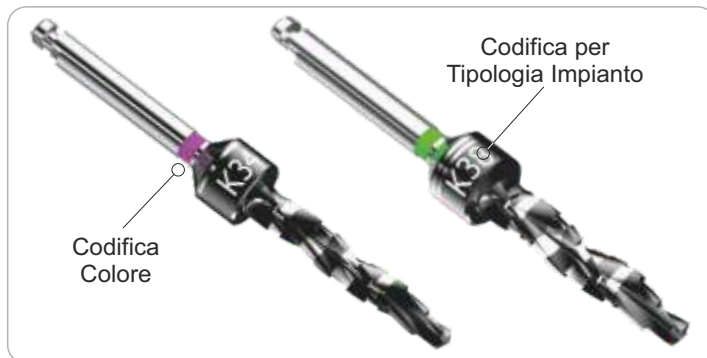

ROTAZIONE ANTIORARIA

La rotazione antioraria, invertendo le forze in gioco, genera 3 effetti differenti sulla pratica chirurgica di preparazione del tunnel implantare, che possono rivoluzionare la logica di fresatura conosciuta.

- 1) Spinta anteriore e laterale dell'osso asportato dalla punta più tutti i liquidi in gioco, sangue e fisiologica.
- 2) Espulsione ad "effetto martello" della fresa, con un miglioramento del controllo verticale.
- 3) Riduzione dell'efficienza di taglio a salvaguardia delle parti anatomiche sensibili.

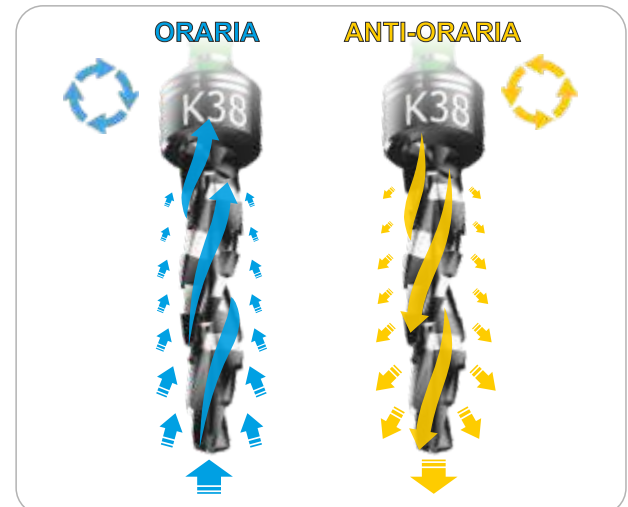

RESISTA PRO MSD SURGICAL DRILLS - Modular Surgical Drilling

The Modular Surgical Drills with variable geometry are 3-section helicoidal drills with progressive radius rake, that can be used clockwise and anticlockwise.

The diameter of each drill changes according to a constant ratio of 0.4mm (30/34/38/42/46/50): this allows the operator to choose the drill according to the bone quality (over-preparation or under-preparation). All the drills are coated with a DLC (Diamond Like Carbon) synthetic diamond solid lubricant that maximizes performance in terms of mechanical strength and friction reduction.

The **anticlockwise rotation**, reversing the involved forces, generates 3 different effects on the implant tunnel perforation, which can revolutionize the known milling logic.

- 1) Anterior and lateral thrust of the bone removed by the tip, and of the liquids as well, blood and physiological water.
- 2) Ejection and "hammer effect" of the drill that produce an improvement in vertical control.
- 3) Reduction of cutting efficiency to protect sensitive anatomical parts.

MICRO IMPLANTS

ONE PIECE TRANSGINGIVAL IMPLANT

MICRO SFERA - MONCONE
CYLINDRICAL SHAPE

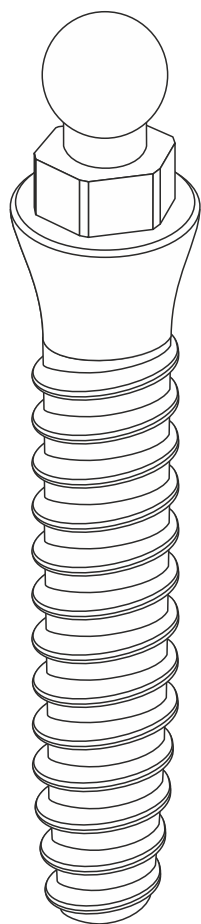

MS

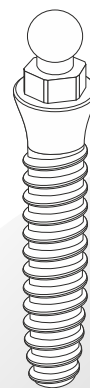

IMPIANTO
SENZA MOUNTER
MOUNTERLESS

MS 27

MICRO IMPLANTS sphere one piece transgingival implant

ONE PIECE MOUNTERLESS

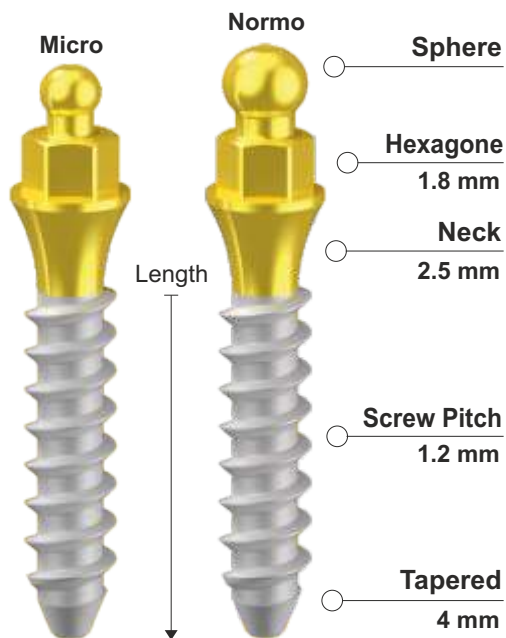

CODE	IMPLANT	LENGTH	PLATFORM	TYPE
MS 2710	Ø 2.7	10 mm	Ø 3.5	Sfera NORMO
MS 2711	Ø 2.7	11.5 mm	Ø 3.5	Sfera NORMO
MS 2713	Ø 2.7	13 mm	Ø 3.5	Sfera NORMO
MSM 2710	Ø 2.7	10 mm	Ø 3.5	Sfera MICRO
MSM 2711	Ø 2.7	11.5 mm	Ø 3.5	Sfera MICRO
MSM 2713	Ø 2.7	13 mm	Ø 3.5	Sfera MICRO

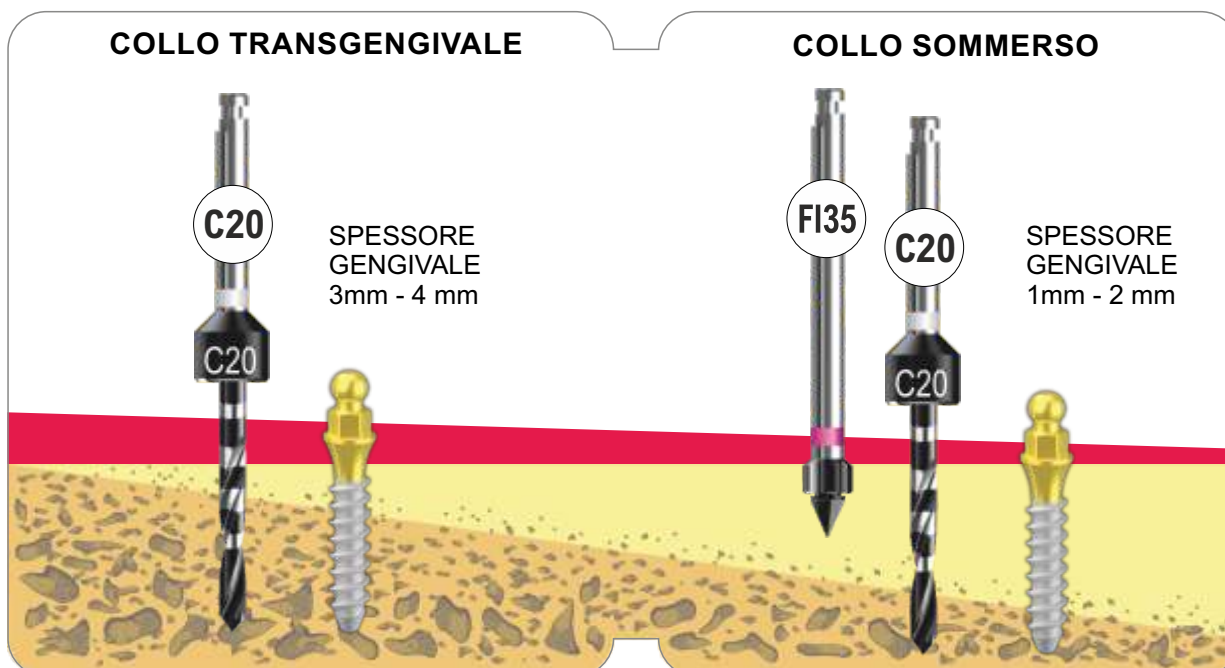

MICRO IMPLANTS abutment

one piece transgingival implant

MM 27

ONE PIECE MOUNTERLESS

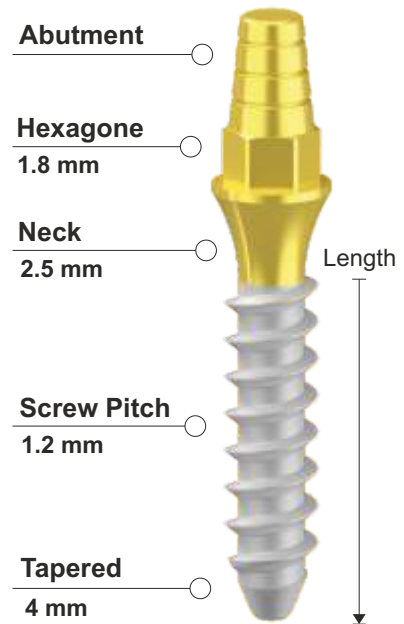
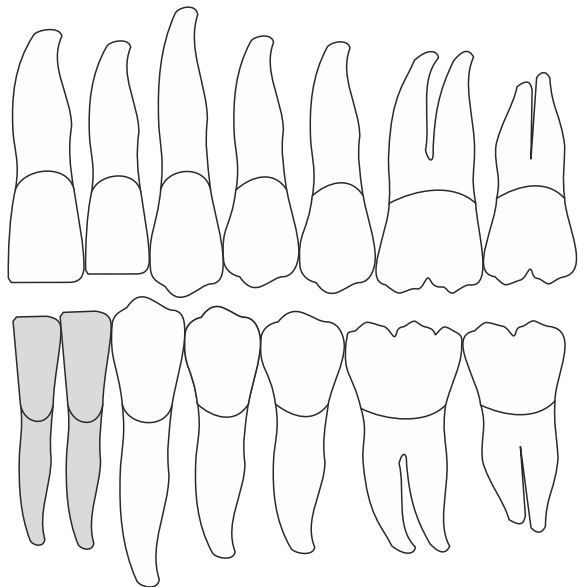

CODE	IMPLANT	LENGTH	PLATFORM	TYPE
MM 2710	Ø 2.7	10 mm	Ø 3.5	Abutment
MM 2711	Ø 2.7	11.5 mm	Ø 3.5	Abutment
MM 2713	Ø 2.7	13 mm	Ø 3.5	Abutment

Protesica per Mini Implants - Titanio Gr 5

Mini Implants Prosthetic Parts - Titanium Gr. 5

PM SN	Normo 2.5mm - Laboratory Analogue
PM SM	Micro 1.8mm - Laboratory Analogue
PM M	Abutment - Laboratory Analogue
PM C	Castable - Universal Antirotational Abutment

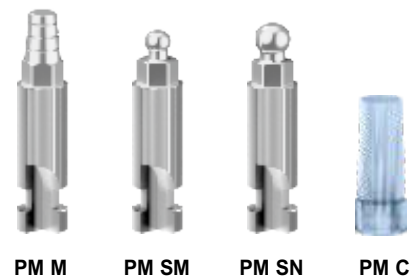

Strumentario per Mini Implants

Mini Implants Instruments

FIS 35	CorTICAL Drill - Ø 3.5 mm
FCS 20	Cylindrical Drill - Ø 2.0 mm - Long 18 mm
PCM	Cricchetto - Ratchet Mini Implant Driver
ACM	Contrangolo - Contrangle Mini Implant Driver



INSTRUMENTS & DRILLS

IMPLANT TOOLS

DRILLS

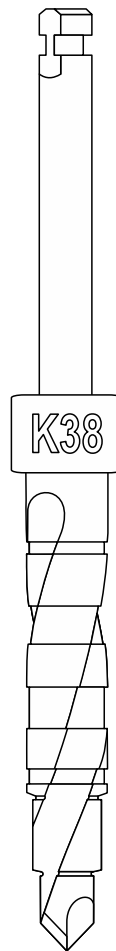

S standard surgical drills

FRESE HBM - Hard Bone Management



07001604 Cortical Drill - Ø 1.6 mm - 11 mm



04002104 Cortical Drill - Ø 2.1 mm - 11 mm



FLS2313 Lance Drill - Ø 2.3 mm - 13 mm

FIS- CORTICALS



FIS 30 Cortical Drill - Ø 3.0 mm



FIS 35 Cortical Drill - Ø 3.5 mm



FIS 40 Cortical Drill - Ø 4.0 mm



FIS 50 Cortical Drill - Ø 5.0 mm

FCS - CYLINDRICALS



FCS 20 Cylindrical Drill - Ø 2.0 mm - Long 18 mm



FCS 30 Cylindrical Drill - Ø 2.6 mm - Long 18 mm



FCS 34 Cylindrical Drill - Ø 2.9 mm - Long 18 mm



FCS 38 Cylindrical Drill - Ø 3.2 mm - Long 18 mm



FCS 42 Cylindrical Drill - Ø 3.6 mm - Long 18 mm



FCS 46 Cylindrical Drill - Ø 3.9 mm - Long 18 mm



FCS 50 Cylindrical Drill - Ø 4.4 mm - Long 18 mm



FCS 55 Cylindrical Drill - Ø 4.7 mm - Long 18 mm

S standard surgical drills

FKS - TAPERED

FKS 30 Tapered Drill - Ø 2.4 mm - Long 18 mm



FKS 34 Tapered Drill - Ø 2.9 mm - Long 18 mm



FKS 38 Tapered Drill - Ø 3.25 mm - Long 18 mm



FKS 42 Tapered Drill - Ø 3.5 mm - Long 18 mm



FKS 46 Tapered Drill - Ø 3.85 mm - Long 18 mm



FKS 50 Tapered Drill - Ø 4.35 mm - Long 18 mm



FKS - EXTRALARGE

FKS 60 Tapered Drill - Ø 5.0 mm - 15 mm



FKS 80 Tapered Drill - Ø 7.0 mm - 15 mm



MUCOTOMI - TISSUE PUNCHES

ST M13 Manual Tissue Punche - Ø3.0mm

ST M14 Manual Tissue Punche - Ø4.1mm

ST M15 Manual Tissue Punche - Ø5.1mm

ST M23 Contrangle Tissue Punche - Ø3.0mm

ST M24 Contrangle Tissue Punche - Ø4.1mm

ST M25 Contrangle Tissue Punche - Ø5.1mm



calibrated surgical drills

FCC 20 - CYLINDRICALS



FCC 2007 Cylindrical Drill - Ø 2.0 mm - Long 7 mm

FCC 2008 Cylindrical Drill - Ø 2.0 mm - Long 8,5 mm

FCC 2010 Cylindrical Drill - Ø 2.0 mm - Long 10 mm

FCC 2011 Cylindrical Drill - Ø 2.0 mm - Long 11,5 mm

FCC 2013 Cylindrical Drill - Ø 2.0 mm - Long 13 mm

FKC 34 - TAPERED



FKC 3407 Tapered Drill - Ø 2.9 mm - Long 7 mm

FKC 3408 Tapered Drill - Ø 2.9 mm - Long 8,5 mm

FKC 3410 Tapered Drill - Ø 2.9 mm - Long 10 mm

FKC 3411 Tapered Drill - Ø 2.9 mm - Long 11,5 mm

FKC 3413 Tapered Drill - Ø 2.9 mm - Long 13 mm

FKC 38 - TAPERED



FKC 3807 Tapered Drill - Ø 3.2 mm - Long 7 mm

FKC 3808 Tapered Drill - Ø 3.2 mm - Long 8,5 mm

FKC 3810 Tapered Drill - Ø 3.2 mm - Long 10 mm

FKC 3811 Tapered Drill - Ø 3.2 mm - Long 11,5 mm

FKC 3813 Tapered Drill - Ø 3.2 mm - Long 13 mm

calibrated surgical drills

FKC 42 - TAPERED

FKC 4207 Tapered Drill - Ø 3.5 mm - Long 7 mm



FKC 4208 Tapered Drill - Ø 3.5 mm - Long 8,5 mm



FKC 4210 Tapered Drill - Ø 3.5 mm - Long 10 mm



FKC 4211 Tapered Drill - Ø 3.5 mm - Long 11,5 mm



FKC 4213 Tapered Drill - Ø 3.5 mm - Long 13 mm



FKC 46 - TAPERED

FKC 4607 Tapered Drill - Ø 3.9 mm - Long 7 mm



FKC 4608 Tapered Drill - Ø 3.9 mm - Long 8,5 mm



FKC 4610 Tapered Drill - Ø 3.9 mm - Long 10 mm



FKC 4611 Tapered Drill - Ø 3.9 mm - Long 11,5 mm



FKC 4613 Tapered Drill - Ø 3.9 mm - Long 13 mm



FKC 50 - TAPERED

FKC 5007 Tapered Drill - Ø 4.3 mm - Long 7 mm



FKC 5008 Tapered Drill - Ø 4.3 mm - Long 8,5 mm



FKC 5010 Tapered Drill - Ø 4.3 mm - Long 10 mm



FKC 5011 Tapered Drill - Ø 4.3 mm - Long 11,5 mm



FKC 5013 Tapered Drill - Ø 4.3 mm - Long 13 mm



universal surgical drills

FC - CYLINDRICALS



FC 2013B Cylindrical Drill - Ø 2.0 mm - 13 mm

FC 2018B Cylindrical Drill - Ø 2.0 mm - 18 mm



FC 2613B Cylindrical Drill - Ø 2.6 mm - 13 mm

FC 2618B Cylindrical Drill - Ø 2.6 mm - 18 mm



FC 3013B Cylindrical Drill - Ø 3.0 mm - 13 mm

FC 3018B Cylindrical Drill - Ø 3.0 mm - 18 mm



FC 3213B Cylindrical Drill - Ø 3.2 mm - 13 mm

FC 3218B Cylindrical Drill - Ø 3.2 mm - 18 mm



FC 3413B Cylindrical Drill - Ø 3.4 mm - 13 mm

FC 3418B Cylindrical Drill - Ø 3.4 mm - 18 mm



FC 3813B Cylindrical Drill - Ø 3.8 mm - 13 mm

FC 3818B Cylindrical Drill - Ø 3.8 mm - 18 mm



FC 4213B Cylindrical Drill - Ø 4.2 mm - 13 mm

FC 4218B Cylindrical Drill - Ø 4.2 mm - 18 mm

F - SPECIAL DRILLS



FLS2313 Lance Drill - Ø 2.3 mm - L13 mm

FLS2318 Lance Drill - Ø 2.3 mm - L18 mm



FBP Bone Profiler - Ø 5.0 mm - Int/Ext Hex
(Velocità Max di rotazione antioraria 80 rpm)



FT 3038 Trephine - Ø 3.0 mm / Ø 3.8 mm

FT 4048 Trephine - Ø 4.0 mm / Ø 4.8 mm

FT 5058 Trephine - Ø 5.0 mm / Ø 5.8 mm

FT 6068 Trephine - Ø 6.0 mm / Ø 6.8 mm



PF Drill Extension - Prolunga per Frese



guided surgical drills

SLEEVE



PEEK
BOC415P

SLEEVE



TITANIUM
BOC415T

SLEEVE



PIN
BOC15

SMALL DRIVER
Ø 4.15



SLEEVE



REDUCER
BOCSR

SLEEVE



PEEK
BOC55P

SLEEVE



TITANIUM
BOC55T

LARGE DRIVER
Ø 5.5



FG - SPECIAL DRILLS

FGR P15

Pins Drill - Ø 1.5 mm

FGR B55 L

Bone Mill Drill - Ø 5.5 mm - ● Large

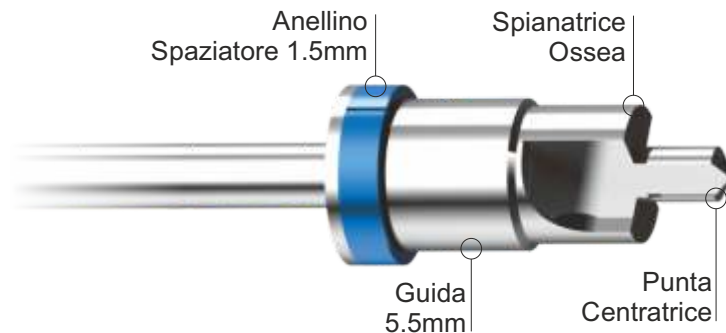

FG M - MUCOTOMES

FGR M41 S

Mucotome Drill - Ø 4.1 mm - ● Small

FGR M45 L

Mucotome Drill - Ø 4.5 mm - ● Large

FGR M55 L

Mucotome Drill - Ø 5.3 mm - ● Large

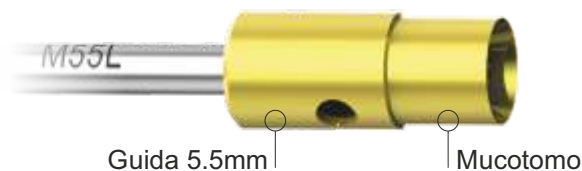

guided surgical drills



FG C - CORTICAL DRILLS



FGR C35 S Cortical Drill - Ø 3.5 mm - ● Small



FGR C40 S Cortical Drill - Ø 4.0 mm - ● Small



FGR C35 L Cortical Drill - Ø 3.5 mm - ● Large



FGR C40 L Cortical Drill - Ø 4.0 mm - ● Large



FGR C50 L Cortical Drill - Ø 5.0 mm - ● Large



FG 20 S - FIRST DRILLS ● Small Driver



FGR 2008 S First Drill - Ø 2.0 mm - Long 8,5 mm

FGR 2010 S First Drill - Ø 2.0 mm - Long 10 mm

FGR 2011 S First Drill - Ø 2.0 mm - Long 11,5 mm

FGR 2013 S First Drill - Ø 2.0 mm - Long 13 mm

FGR 2015 S First Drill - Ø 2.0 mm - Long 15 mm

FG 20 L - FIRST DRILLS ● Large Driver



FG 2008 L First Drill - Ø 2.0 mm - Long 8,5 mm

FGR 2010 L First Drill - Ø 2.0 mm - Long 10 mm

FGR 2011 L First Drill - Ø 2.0 mm - Long 11,5 mm

FGR 2013 L First Drill - Ø 2.0 mm - Long 13 mm

FGR 2015 L First Drill - Ø 2.0 mm - Long 15 mm



guided surgical drills

FG 34 L - 3.4 IMPLANT DRILLS ● Small Driver

- FGR 3408 S** 3.4 Implant Drill - Ø 2.9 mm - Long 8,5 mm
- FGR 3410 S** 3.4 Implant Drill - Ø 2.9 mm - Long 10 mm
- FGR 3411 S** 3.4 Implant Drill - Ø 2.9 mm - Long 11,5 mm
- FGR 3413 S** 3.4 Implant Drill - Ø 2.9 mm - Long 13 mm
- FGR 3415 S** 3.4 Implant Drill - Ø 2.9 mm - Long 15 mm



FG 34 L - 3.4 IMPLANT DRILLS ● Large Driver

- FGR 3408 L** 3.4 Implant Drill - Ø 2.9 mm - Long 8,5 mm
- FGR 3410 L** 3.4 Implant Drill - Ø 2.9 mm - Long 10 mm
- FGR 3411 L** 3.4 Implant Drill - Ø 2.9 mm - Long 11,5 mm
- FGR 3413 L** 3.4 Implant Drill - Ø 2.9 mm - Long 13 mm
- FGR 3415 L** 3.4 Implant Drill - Ø 2.9 mm - Long 15 mm



FG 38 S - 3.8 IMPLANT DRILLS ● Small Driver

- FGR 3808 S** 3.8 Implant Drill - Ø 3.3 mm - Long 8,5 mm
- FGR 3810 S** 3.8 Implant Drill - Ø 3.3 mm - Long 10 mm
- FGR 3811 S** 3.8 Implant Drill - Ø 3.3 mm - Long 11,5 mm
- FGR 3813 S** 3.8 Implant Drill - Ø 3.3 mm - Long 13 mm
- FGR 3815 S** 3.8 Implant Drill - Ø 3.3 mm - Long 15 mm



FG 38 L - 3.8 IMPLANT DRILLS ● Large Driver

- FGR 3808 L** 3.8 Implant Drill - Ø 3.3 mm - Long 8,5 mm
- FGR 3810 L** 3.8 Implant Drill - Ø 3.3 mm - Long 10 mm
- FGR 3811 L** 3.8 Implant Drill - Ø 3.3 mm - Long 11,5 mm
- FGR 3813 L** 3.8 Implant Drill - Ø 3.3 mm - Long 13 mm
- FGR 3815 L** 3.8 Implant Drill - Ø 3.3 mm - Long 15 mm



guided surgical drills



FG 42 S - 4.2 IMPLANT DRILLS ● Small Driver



- FGR 4208 S** 4.2 Implant Drill - Ø 3.6 mm - Long 8,5 mm
- FGR 4210 S** 4.2 Implant Drill - Ø 3.6 mm - Long 10 mm
- FGR 4211 S** 4.2 Implant Drill - Ø 3.6 mm - Long 11,5 mm
- FGR 4213 S** 4.2 Implant Drill - Ø 3.6 mm - Long 13 mm
- FGR 4215 S** 4.2 Implant Drill - Ø 3.6 mm - Long 15 mm

FG 42 L - 4.2 IMPLANT DRILLS ● Large Driver



- FGR 4208 L** 4.2 Implant Drill - Ø 3.6 mm - Long 8,5 mm
- FGR 4210 L** 4.2 Implant Drill - Ø 3.6 mm - Long 10 mm
- FGR 4211 L** 4.2 Implant Drill - Ø 3.6 mm - Long 11,5 mm
- FGR 4213 L** 4.2 Implant Drill - Ø 3.6 mm - Long 13 mm
- FGR 4215 L** 4.2 Implant Drill - Ø 3.6 mm - Long 15 mm

FG 46 L - 4.6 IMPLANT DRILLS ● Large Driver



- FGR 4608 L** 4.6 Implant Drill - Ø 3.9 mm - Long 8,5 mm
- FGR 4610 L** 4.6 Implant Drill - Ø 3.9 mm - Long 10 mm
- FGR 4611 L** 4.6 Implant Drill - Ø 3.9 mm - Long 11,5 mm
- FGR 4613 L** 4.6 Implant Drill - Ø 3.9 mm - Long 13 mm
- FGR 4615 L** 4.6 Implant Drill - Ø 3.9 mm - Long 15 mm

FG 50 L - 5.0 IMPLANT DRILLS ● Large Driver



- FGR 5008 L** 5.0 Implant Drill - Ø 4.3 mm - Long 8,5 mm
- FGR 5010 L** 5.0 Implant Drill - Ø 4.3 mm - Long 10 mm
- FGR 5011 L** 5.0 Implant Drill - Ø 4.3 mm - Long 11,5 mm
- FGR 5013 L** 5.0 Implant Drill - Ø 4.3 mm - Long 13 mm



guided surgical drills

GUIDED MOUNTERS

- IP4MG 4S** Mounter Guidata - Internal Hex ● Small Drive
- IP4MG 4L** Mounter Guidata - Internal Hex ● Large Drive

- SP3MG 3S** Mounter Guidata - External Hex ● Small Drive
- SP4MG 4S** Mounter Guidata - External Hex ● Small Drive
- SP4MG 4L** Mounter Guidata - External Hex ● Large Drive

- IP3MG 3S-P** Mounter Guidata - Platinum CC ● Small Drive
- IP3MG 3L-P** Mounter Guidata - Platinum CC ● Large Drive
- IP4MG 4L-P** Mounter Guidata - Platinum CC ● Large Drive

Small Drive



Large Drive



Large Drive



Allineatori di Fase Esagonale
Hexagonal Phase Aligners



Large Peek Sleeve



Small Peek Sleeve



Large Titanium Sleeve



Small Titanium Sleeve



surgical kits



BOX
Solo contenitore

KIT 002
C-K-A Multilinea



KIT FCK
Calibrate K



surgical kits

KIT 001MC	Kit Chirurgico Monolinea Cilindriche - BOX02 + Frese + Accessori
KIT 001MK	Kit Chirurgico Monolinea Coniche - BOX02 + Frese + Accessori
KIT 001PC	Kit Chirurgico Monolinea Platinum Cilindriche - BOX02 + Frese + Accessori
KIT 001PK	Kit Chirurgico Monolinea Platinum Coniche - BOX02 + Frese + Accessori
KIT 002	Kit Chirurgico Standard - BOX + Frese + Accessori
KIT 002P	Kit Chirurgico Platinum Standard - BOX + Frese + Accessori
KIT 004	Kit Chirurgico Mini Implant - BOX 03 + CRND + Frese + Accessori
KIT FCK	Kit Chirurgico Calibrate K - BOX FCK + Frese + Accessori
KIT 009	Kit Chirurgico UNI-Q-MUA 2.0 - BOX 02 + Frese + Accessori
KIT RPS01	Kit Protesico REPLICA - BOX RP01 + 5 Drivers Corti
KIT RPS02	Kit Protesico REPLICA - BOX RP01 + 5 Drivers Corti + Cricchetto Dinamom.
KIT RPL01	Kit Protesico REPLICA - BOX RP01 + 5 Drivers Lunghi
KIT RPL02	Kit Protesico REPLICA - BOX RP01 + 5 Drivers Lunghi + Cricchetto Dinamom.
BOX	Box Chirurgico Implantologia Large - Solo contenitore
BOX 02	Box Chirurgico Implantologia Monolinea Medium - Solo contenitore
BOX RP01	Box Protesico REPLICA - Solo contenitore



KIT 001
Monolinea



Kit Protesico
REPLICA

surgical kits

KIT 005	Kit Chirurgico Espansori - BOX 03 + 4 Espansori + Accessori
KIT 006	Kit Chirurgico Espansori Base - BOX 03 + 4 Espansori
KIT PINK	Kit Misuratori di Parallelismo - BOX P + 10 PIN
KIT 007	Kit Rimozione Impianti EXT - BOX 03 + 2 Estrattori + Accessori
KIT RI	Kit Rimozione Impianti REPLICA - BOX + 3 Estrattori + 4 Viti + Accessori
KIT RV	Kit Rimozione Viti Fratturate REPLICA - BOX + 2 Frese + Guida + Accessori
KIT 012	Kit REVO Chirurgia Guidata - BOX + 59 Frese + Accessori
KIT 012L	Kit REVO Chirurgia Guidata solo Frese Larghe - BOX + 36 Frese + Accessori
BOX GR	Box REVOLUTION Chirurgia Guidata - Solo contenitore
KIT KN	Kit K Narrow - Box + Frese + Accessori
BPIF	Base Svita Impianti - Base in Titanio per la Rimozione del Mount
KBS	Kit Boccole Spaziatrici - 8 Boccole 2 colori per tipo + Box Inox
RBS	Ricambi Boccole Spaziatrici - 8 Boccole 2 colori per tipo



KBS Kit Boccole Spaziatrici REVO



BPIF Base Svita Impianti

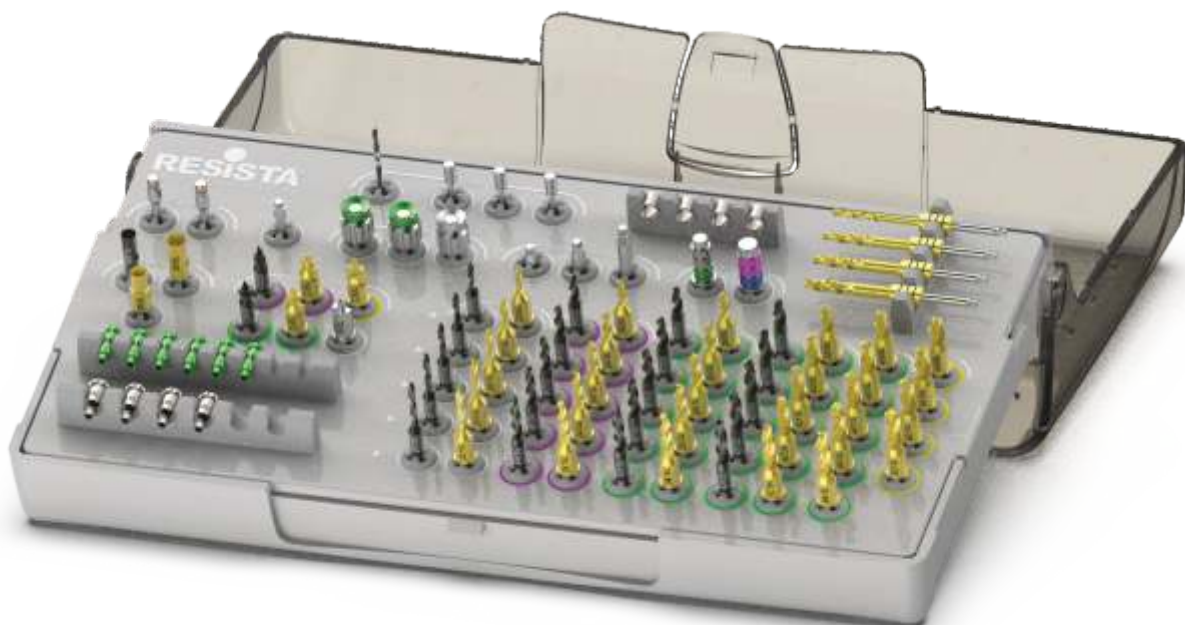

Guided Surgery REVO (Full Optional su Richiesta)

computer guided surgery



computer guided surgery

MASCHERINA CHIRURGICA - Mascherina on demand multi-impianti

SURGICAL GUIDE - Multi-implants on demand surgical guide

DS PAK Progetto + Mascherina + Modello + Boccole

NB - Supporto tecnico sul posto per i primi 3 interventi
Kit Chirurgico in comodato d'uso per i primi 3 interventi

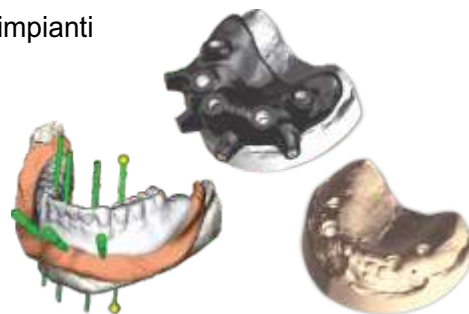

MASCHERINA CHIRURGICA - Mascherina on demand multi-impianti

SURGICAL GUIDE - Multi-implants on demand surgical guide

DS PAK-M Progetto + Mascherina + Boccole

NB - Supporto tecnico sul posto per i primi 3 interventi
Kit Chirurgico in comodato d'uso per i primi 3 interventi

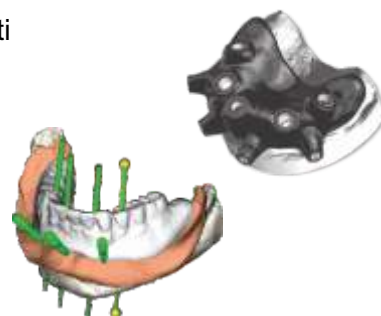

MODELLO MASTER - Modello stereolitografato, preforato per analoghi

MASTER MODEL - Pre-drilled stereolithographed model for analog

DS MOD Modello da stampa Digitale di precisione



MASCHERINA CHIRURGICA - Mascherina on demand multi-impianti

SURGICAL GUIDE - Multi-implants on demand surgical guide

DS PAK 1 Mascherina 1 Impianto + Modello + Boccole

DS PAK 4 Mascherina 4 Impianti + Modello + Boccole

DS PAK 8 Mascherina 8 Impianti + Modello + Boccole

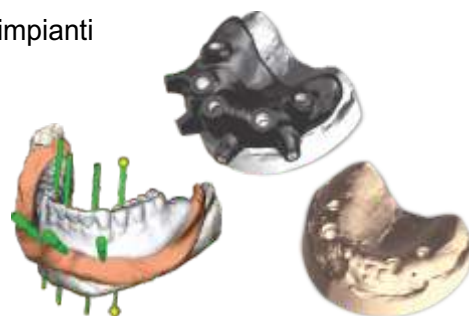

PROTESI PROVVISORIA IMMEDIATA - PMMA Stratificato Fresato + Armatura in Titanio Fresata

IMMEDIATE TEMPORARY PROSTHESIS - Drilled PMMA + Milled Titanium Framework

DS PTD Protesi Provvisoria Total Digital - PMMA + Armatura



computer guided surgery

1

MODELLO PANORAMICO - Ottenuto dalla ribasatura della protesi

Modello di precisione, integro, squadrato e rifinito

Materiale: Gesso di qualità Classe 4

Ribasare la protesi con materiale da impronta o prendere un'impronta di precisione se parzialmente edentulo



2

DUPLICATO DELLA PROTESI - Realizzato sul modello panoramico

Copia conforme della protesi mobile senza sottosquadri vestibolari

Materiale: Resina ortodontica trasparente

Il dupliato è una copia di precisione di una protesi o di una ceratura diagnostica se il paziente è parzialmente edentulo



3

MARKER RADIOLOGICI - Incollaggio delle palline di quarzo

6/8 palline, in posizioni sfalsate non lineari tra loro

Materiale: Sfere di quarzo delle sterilizzatrici a palline

Le palline vanno incollate con cianocrilato per metà del loro diametro nella resina ed il resto emergente, con posizioni sfalsate tra loro



4

TAC CONE BEAM - Rimuovere ponti e corone metalliche se possibile

Paziente con duplicato in bocca e spaziatore intraorale tra le arcate

Dati DICOM standard inviati via mail in una cartella compressa

Il metallo di ponti e corone genera grandi quantità di scattering che altera l'interpretazione dei dati DICOM e la precisione



5

STL ANATOMIA e WAXUP PROTESICO - 2/3 File STL

1 File STL Modello Gengivale/Dentale

1 File STL Modello + WaxUp Protesico (Duplicato della Protesi)

Inviare per e-mail in cartella compressa



6

CREAZIONE DEL CASO - Ambiente virtuale per progettazione chirurgica

Trasformiamo il vostro materiale in un caso unico, già caricato nel

Programma di Pianificazione e ve lo condividiamo sul vostro Software

I file STL di modello, duplicato e/o scan-marker, li sovrapponiamo alla TAC (matching) all'interno del programma, per visualizzare ossa, tessuti molli e protesi

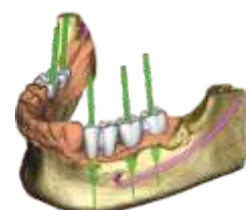

computer guided surgery

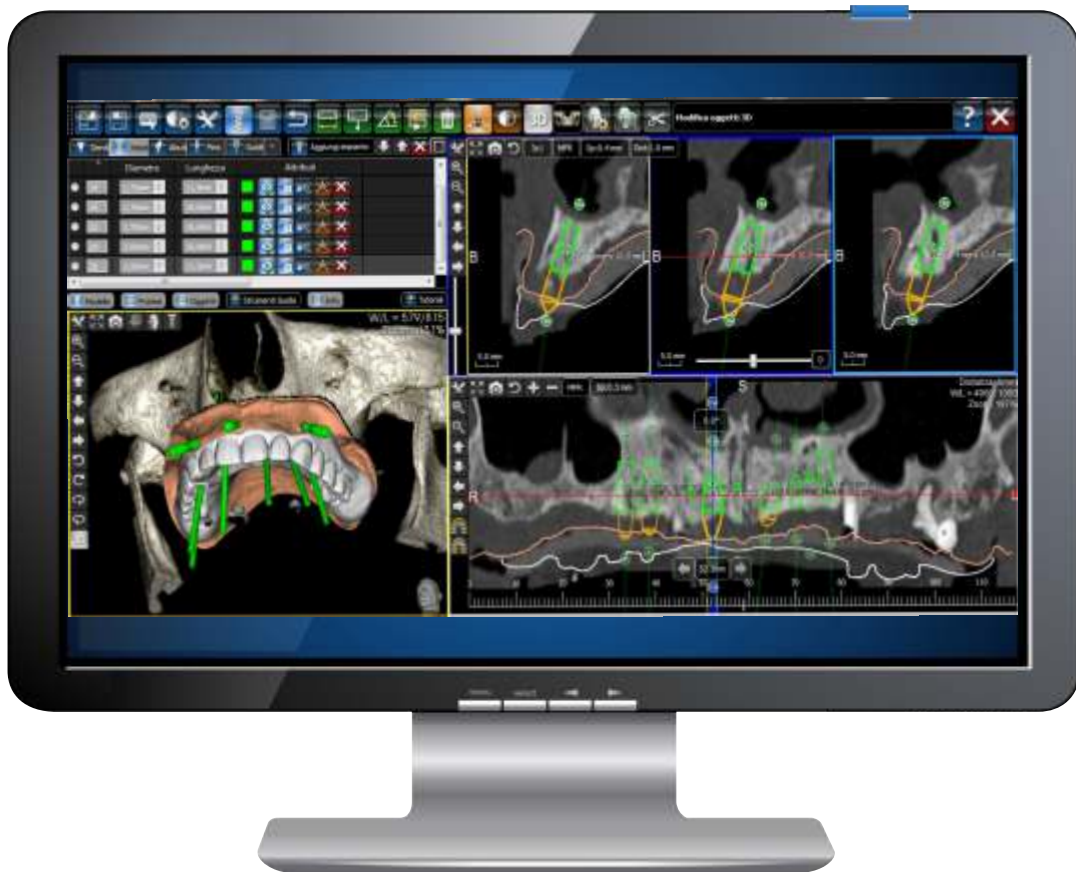

CORSI DI FORMAZIONE TEORICO/PRATICI SU PC

Il futuro è digitale e la chirurgia computer guidata cammina al fianco della rivoluzione cad-cam che sta trasformando il nostro lavoro

impararne le basi, conoscerne le potenzialità, comprenderne i limiti per evitare errori e per migliorare il nostro quotidiano

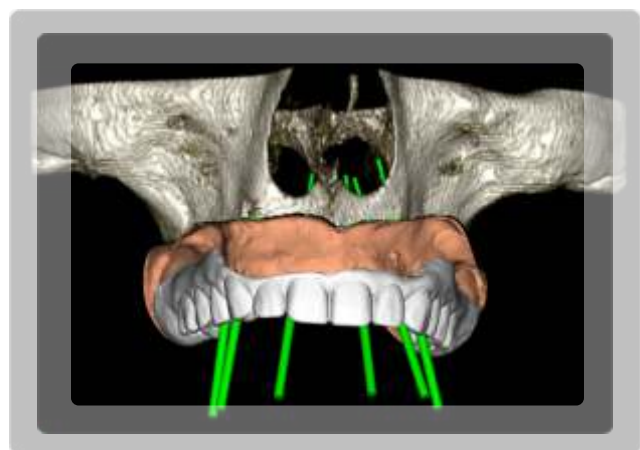
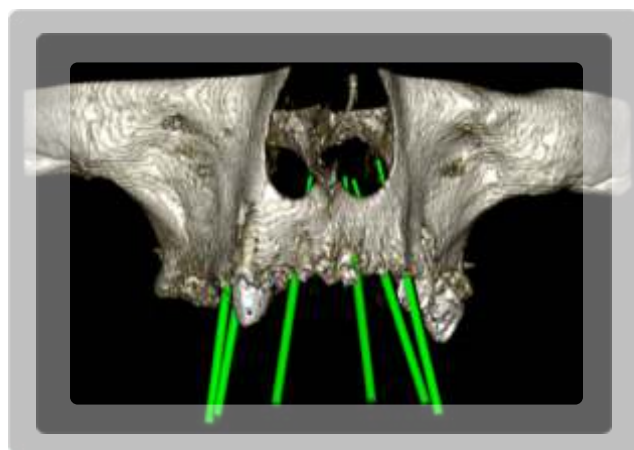

instruments and tools

AVVITATORE PER MINI IMPIANTI - MINI IMPLANT DRIVER



PCM

Cricchetto - Ratchet **Mini Implant Driver**



ACM

Contrangolo - Contrangle **Mini Implant Driver**

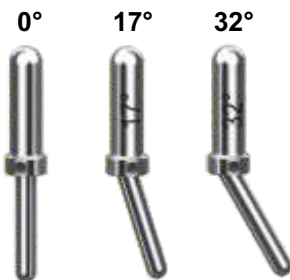

Perni di Parallelismo - Titanio Gr. 5

Paralleling Pins - Titanium Gr. 5

PIN Double diameter - S 1.8mm / L 3mm - 0°

PIN17 Double diameter - S 1.8mm / L 3mm - 17°

PIN32 Double diameter - S 1.8mm / L 3mm - 32°

PIN K Kit Misuratori di Parallelismo Calibrati (10 PIN + BOX)

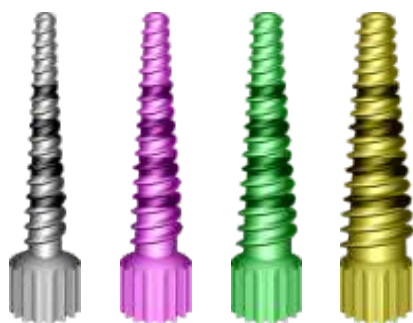

Osseo Espansori e Compattatori - Titanio Gr. 5

Bone Expanders and Compactors - Titanium Gr. 5

EXP 4 Progressive diameters

KIT 005 Expander Surgical Kit

A 1.3
B 2.1
C 2.4

A 1.6
B 2.8
C 3.1

A 1.9
B 3.5
C 3.8

A 2.4
B 4.3
C 4.6

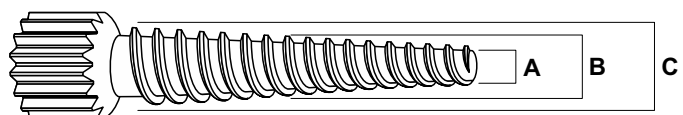

instruments and tools

Avvitatori Manuali - Acciaio Inox

Manual Driver - Stainless Steel



CRND Cricchetto non Dinamometrico - No Torque Control Ratchet



CRD2-G



CRD2 Cricchetto Dinamometrico 10/70 Ncm - Torque Control

CRD2-G Ghiera Cricchetto CRD2 con Attacco PC - CRD2 Ratchet Wheel with PC Connection



CRDP2 Cricchetto Dinamometrico Protesico 10/70 Ncm - Torque Control



CDL Avvitatore Diritto Manuale - Long Manual Driver

Sonde e Misuratori - Acciaio Inox

Probes and Meters - Stainless Steel

ST PRO SL1 Sonda Compattatore Doppia - Sinus Lift System



SOM Sonda Chirurgica in Titanio
Titanium Surgical Probe

mini sinus lift

Frese Taglienti 120°



PRO Sinus Lift - Mini Rialzo del Seno per via Crestale

PRO Sinus Lift - Mini Sinus Lift with Crestal Approach

PRO SL Kit Kit Completo Box + Frese + Stop + Accessori

- FC 20** Fresa ● Tagliente 120° - Ø 2.0
- FC 2026** Fresa ● Tagliente 120° - Ø 2.0/2.6
- FC 2531** Fresa ● Tagliente 120° - Ø 2.5/3.1
- FC 31P** Fresa ● Atraumatica 180° - Ø 3.1
- FC 31PTX** Fresa ● Atraumatica TaglioX 180° - Ø 3.1
- FC 31R** Fresa ● Raggiata Atraumatica - Ø 3.1
- FC 3136R** Fresa ● Raggiata Atraumatica - Ø 3.1/3.6

KIT ST 6 Titanium Drill Stoppers
(6.0/7.0/8.5/10/11.5/13)

STP KIT 11 Titanium Drill Stoppers
(1.0/2.0/3.0/4.0/5.0/6.0/7.0/8.5/10/11.5/13)

ST Titanium Drill Stopper 1 pz. (Es. ST1, ST2, ST3)

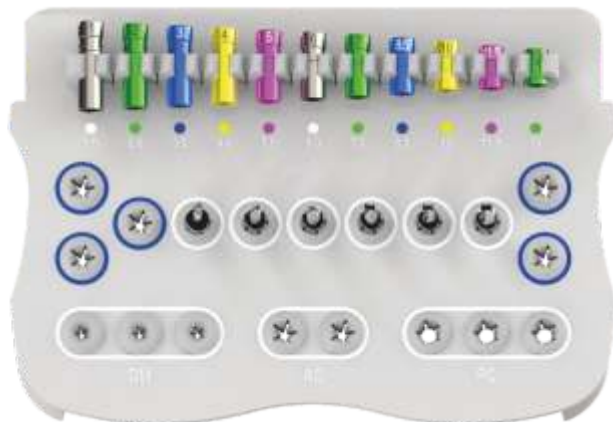

Frese Atraumatiche (Max 100 rpm)



Frese Raggiate (Max 80 rpm)



instruments and surgery

IMPIANTI FRATTURATI

UNIVERSAL IMPLANT EXTRACTOR

IMPIANTO
FRATTURATO



IMPIANTO
SOSTITUITO

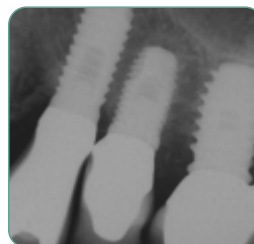

RIMOZIONE IMPIANTO IN
AVVITAMENTO ANTIORARIO



SOSTITUZIONE IMMEDIATA
CON NUOVO IMPIANTO



RIVESTIMENTO IN DLC
Durezza e Minore Attirito

FILETTO 3 PRINCIPI
120Ncm

CONICITÀ PROGRESSIVA
Incrementale

ACCIAIO EXTRADURO
68 Rockwell



EXT Implant Extractor - 1 pcs.

KIT 007 Implant Extractor Kit - 2 Extractors + 1 Box + CRND

Siringhe per Anestesia - Inox

Anesthesia Syringes - Stainless Steel



PERIPEN



PERIPRESS



22 PERIPRESS - Siringa Inox 1.8cc - Set 2 Portafiala

32 PERIPRESS - Siringa Standard 1.8cc - Set 2 Portafiala

118 PERIPEN - Siringa Inox 1.8cc - Set 2 Portafiala AM/EU



Ing. C. A. Issoglio & C. S.r.l.
Via F.lli Di Dio, 68 - 28887 Omegna (VB) - ITALIA
Tel. +39.0323.828.004 - Fax +39.0323.828.914
www.resista.it - info@resista.it

REV 03 - 31/03/2023